

Video • Data • Power



Passive UTP Transceiver Hub with Integral Camera Power

Installation Guide

Models Include:

HubSat4WPV

- *Four (4) Channel Outdoor Passive UTP Transceiver Hub with Integral Camera Power*

HubSat42WPV

- *Four (4) Channel Outdoor Passive UTP Transceiver includes four (4) HubWayAv
Video Balun/Combiners*

HubSat43WPV

- *Four (4) Channel Outdoor Passive UTP Transceiver includes four (4) HubWayDv
Video Balun/Combiners*



Rev. 060210



More than just power.™

Table of Contents:

Overview	<i>pg. 3</i>
Specifications	<i>pg. 3</i>
Additional Models	<i>pg. 3</i>
Installation Instructions	
HubSat4WPV Outdoor Passive UTP Transceiver Hub with Integral Camera Power	<i>pg. 3</i>
HubSat4WPV for Use as a Remote Accessory Module with	
HubWay/HubWayLD/HubWayLDH UTP Transceiver Hubs	<i>pg. 4</i>
Alternate 24VAC Fixed Camera Hookup	<i>pg. 5</i>
HubSat Circuit Board	<i>pg. 6</i>
HubWayAv, HubWayAv2, HubWayDv, and HubWayDvi Video Balun/Combiners	<i>pg. 7</i>
CAT-5 Structured Cable Wiring Color Codes	<i>pg. 7</i>
Typical Application Drawings	
HubSat4WPV Passive UTP Transceiver Hub with Integral Camera Power	<i>pg. 9</i>
HubSat4WPV Remote Accessory Module with HubWay UTP Transceiver Hubs	<i>pg. 9</i>
Wall Mount Installation	<i>pg. 10</i>
Pole Mounting Using Optional Pole Mount Kit PMK1	<i>pg. 10</i>
Enclosure Dimensions	<i>pg. 12</i>

Overview:

Altronix HubSat4WPV Passive UTP Transceiver Hub with Integral Camera Power transmits UTP video, RS422/RS485 data and power over a single CAT-5 or higher structured cable. Unit provides 4 camera channels in a wall mount enclosure. Video transmission range is up to 750 ft. max. per channel. Units are compatible with AC and/or DC fixed or PTZ cameras when utilizing Altronix HubWayAv, HubWayAv2, HubWayDv or HubWayDvi Video Balun/Combiners. In addition, the unit features individually selectable 24VAC or 28VAC PTC protected outputs with surge suppression. Optionally, the HubSat4WPV can be used as an accessory module to transmit video from up to 4 cameras over a single CAT-5 or higher structured cables back to the HubWay, HubWayLD or HubWayLDH Passive and Active UTP Transceiver Hubs. In addition, the HubSat4WPV provides power to these cameras locally to eliminate the possibility of voltage drop associated with long cable runs.

Specifications:

Input:

- 220VAC, 50/60Hz, 0.7A.

Video:

- Four (4) channels of quality video over twisted pair up to a distance of 750 ft. per channel.
- Four (4) 75 Ohm video outputs.

Data:

- RS422/RS485 data input.

Power:

- Individually selectable 24VAC or 28VAC power outputs with OFF position.
- Unit provides up to 1A max. per channel not to exceed a total of 4A maximum current.

Power (cont'd):

- PTC protected outputs are rated @ 1A per channel.
- Surge suppression.

Visual Indicators:

- Four (4) power LED indicators.

Enclosure Dimensions (H x W x D approx.):

12" x 8" x 6" (304.8mm x 203.2mm x 152.4mm)

Optional Accessories:

- Video Balun/Combiners:
 - HubWayAv - for use with 24VAC cameras.
 - HubWayAv2 - for use with 24VAC cameras.
 - HubWayDv - for use with 12VDC cameras.
 - HubWayDvi - for use with non-isolated 12VDC cameras.

Additional Models:

HubSat42WPV

- HubSat4WPV with four (4) HubWayAv Video Balun/Combiners for 24VAC Cameras.

HubSat43WPV

- HubSat4WPV with four (4) HubWayDv Video Balun/Combiners for 12VDC Cameras.

WARNING: To reduce the risk of fire or electric shock do not expose the unit to rain or moisture. This installation should be made by qualified service personnel and should conform to all local codes.

Installation Instructions:

HubSat4WPV Outdoor Passive UTP Transceiver Hub with Integral Camera Power.

Unit should be installed in accordance with The National Electrical Code and all applicable Local Regulations.

1. Remove back plate inside the enclosure by removing the four (4) mounting screws (*Fig. 4, pg. 8*).
2. Mark and drill desired knockouts on the enclosure to facilitate wiring (*Fig. 1, pg. 6*).
3. Secure back plate inside the enclosure with the four (4) mounting screws (*Fig. 4b, pg. 8*).
4. Unit can be wall or pole mounted.

Wall Mount:

- Mark and drill holes to line up with the top and bottom holes of the enclosure flange.
- Secure enclosure with appropriate fasteners (*Enclosure Dimensions, pg. 12*).

Pole Mount:

- Refer to the detailed pole mount instructions (*pg. 10*).

Secure enclosure to earth ground.

4. Set illuminated master power disconnect circuit breaker to the (OFF) position (*Fig. 4a, pg. 8*).
5. Connect 220VAC 50/60Hz to the black and white flying leads of open frame transformer. Secure ground wire (Green) to earth ground (*Fig. 4, pg. 8*).
6. Select 24VAC or 28VAC power output for each of the Channels 1-4 on HubSat4WPV (*Fig. 4, pg. 8*) with the corresponding output voltage switches. Select OFF position when servicing or installing individual cameras (*Fig. 2d, pg. 6*).
7. Connect the BNC video outputs marked [Video 1-4] on HubSat4WPV to the corresponding video inputs on the head end equipment (DVR) (*Fig. 2a, pg. 6*).
8. Connect terminals marked [+ DATA -] on HubSat4WPV (polarity must be observed) to the RS422/RS485 output of the head end equipment (DVR) (*Fig. 2f, pg. 6*). When using fixed cameras disregard this step.

9. Plug the RJ45 connector at one end of the CAT-5 or higher structured cable into the RJ45 jack marked [PVD1] on HubSat4WPV (*Fig. 2i, pg. 6*). Plug the RJ45 connector at the opposite end of the CAT-5 or higher structured cable into the RJ45 jack of the Video Balun/Combiner to be installed at camera 1.
 - For 24VAC cameras use Altronix model HubWayAv/HubWayAv2 Video Balun/Combiner (*Figs. 3a, 3b, pg. 7*).
 - For 12VDC cameras use Altronix model HubWayDv Video Balun/Combiner (*Figs. 3c, 3d, pg. 7*).
 - For non-isolated 12VDC cameras use Altronix model HubWayDvi Video Balun/Combiner (*Figs. 3c, 3d, pg. 7*).

The total cable distance must not exceed 750 ft. for video transmission between the HubSat4WPV and each camera. Repeat this step for all other camera channels [PVD2-4].
10. Set illuminated master power disconnect circuit breaker to the RESET (ON) position (*Fig. 4a, pg. 8*). Power LEDs (Green) of the HubSat4WPV will illuminate when AC power is present (*Fig. 2e, pg. 6*) and HubWayAv, HubWayDv or HubWayDvi Video Balun/Combiner LEDs will illuminate indicating power is present (*Fig. 3b, 3d, pg. 7*).
11. Measure the output voltage at each Video Balun/Combiner (*Figs. 3b, 3d, pg. 7*) before making connections to each camera to ensure proper operation and avoid possible damage.
12. Set illuminated master power disconnect circuit breaker to the (OFF) position (*Fig. 4a, pg. 8*).
13. Connect power outputs of HubWayAv, HubWayAv2, HubWayDv or HubWayDvi Video Balun/Combiners to power inputs of cameras (*Figs. 3a-3d, pg. 7*). Polarity must be observed.
 - HubWayAv/HubWayAv2 - Terminals marked [AC POWER] (*Figs. 3a, 3b, 3e, pg. 7*).
 - HubWayDv/HubWayDvi - Terminals marked [- 12VDC +] (*Figs. 3c, 3d, pg. 7*).
14. Connect the terminals marked [+ DATA -] of HubWayAv, HubWayAv2, HubWayDv or HubWayDvi Video Balun/Combiners to data input terminals of cameras for PTZ control (*Figs. 3a-3e, pg. 7*). Polarity must be observed. When using fixed cameras disregard this step.
15. Connect the BNC connector of HubWayAv, HubWayAv2, HubWayDv or HubWayDvi Video Balun/Combiners to the BNC video outputs of cameras (*Figs. 3a-3e, pg. 7*).
16. Set illuminated master power disconnect circuit breaker to the RESET (ON) position (*Fig. 4a, pg. 8*).
17. The power LEDs (Green) of the HubSat4WPV will illuminate when AC power is present (*Fig. 2e, pg. 6*).

Note: If any of the power LEDs are not illuminated the cause may be due to the following:

 - a. AC mains fail.
 - b. Illuminated master power disconnect circuit breaker is tripped.
 - c. An individual power output voltage switch is set to the OFF position (*Fig. 2d, pg. 6*).
 - d. A PTC is tripped due to a short circuit or overload condition for one or more channels/power outputs. To reset the PTC:
 1. Set the voltage output selector switch for that corresponding channel to the OFF position. Switch must remain in the OFF position for approximately 2 minutes in order for the PTC to reset (*Fig. 2d, pg. 6*).
 2. Eliminate the trouble condition (short circuit or overload).
 3. Set the voltage output selector switch for either 24VAC or 28VAC (*Fig. 2d, pg. 6*).

HubSat4WPV for use as a Remote Accessory Module with HubWay/HubWayLD/HubWayLDH UTP Transceiver Hubs.

After completing steps 1-4 of Installation Instructions for HubSat4WPV Outdoor Passive UTP Transceiver Hub with Integral Camera Power proceed with the following.

1. For fixed cameras run a single CAT-5 cable between HubSat4WPV and HubWay, HubWayLD or HubWayLDH to allow video transmission of up to four (4) cameras. For PTZs run two (2) CAT-5 cables between HubSat4WPV and HubWay, HubWayLD or HubWayLDH (*Fig. 6, pg. 9*).
 - a. Connect one (1) of the CAT-5 cables to the RJ45 jack marked [Video 1-4] on HubSat4WPV. Connect the opposite end of this CAT-5 cable into the RJ45 jack marked [CH 1-4] of HubWay, HubWayLD or HubWayLDH unit (*Fig. 6, pg. 9*).
 - b. For data (PTZ) connect the second CAT-5 cable to the RJ45 jack marked [Data 1-4] on HubSat4WPV. Connect the opposite end of this CAT-5 cable into any unused RJ45 jack marked [1-16] of HubWay, HubWayLD or HubWayLDH unit (*Fig. 6, pg. 9*).

Note: Data inputs of HubWay, HubWayLD or HubWayLDH units must be wired in parallel for proper operation. When using fixed cameras disregard this step.
2. Plug the RJ45 connector at one end of the CAT-5 or higher structured cable into the RJ45 jack marked [PVD1] on HubSat (*Fig. 2i, pg. 6*). Plug the RJ45 connector at the opposite end of the CAT-5 or higher structured cable into the RJ45 jack of the Video Balun/Combiner to be installed at camera 1.
 - For 24VAC cameras use Altronix model HubWayAv/HubWayAv2 Video Balun/Combiner (*Figs. 3a, 3b, 3e, pg. 7*).
 - For 12VDC cameras use Altronix model HubWayDv Video Balun/Combiner (*Figs. 3c, 3d, pg. 7*).
 - For non-isolated 12VDC cameras use Altronix model HubWayDvi Video Balun/Combiner (*Figs. 3c, 3d, pg. 7*).

- The total cable distance must not exceed 750 ft. for video transmission between the HubSat4WPV and each camera. Repeat this step for all other camera channels [PVD2-4].
3. Set illuminated master power disconnect circuit breaker to the RESET (ON) position (*Fig. 4a, pg. 8*). Power LEDs (Green) of the HubSat4WPV will illuminate when AC power is present (*Fig. 2e, pg. 6*) and HubWayAv, HubWayDv or HubWayDvi Video Balun/Combiner LEDs will illuminate indicating power is present (*Fig. 3b, 3d, pg. 7*).
 4. Measure the output voltage at each Video Balun/Combiner (*Figs. 3b, 3d, 3e, pg. 7*) before making connections to each camera to ensure proper operation and avoid possible damage.
 5. Set illuminated master power disconnect circuit breaker to the (OFF) position (*Fig. 4a, pg. 8*).
 6. Connect power outputs of HubWayAv, HubWayAv2, HubWayDv or HubWayDvi Video Balun/Combiners to power inputs of cameras (*Figs. 3a-3e, pg. 7*). Polarity must be observed.
 - HubWayAv/HubWayAv2 - Terminals marked [AC POWER] (*Figs. 3a, 3b, pg. 7*).
 - HubWayDv/HubWayDvi - Terminals marked [- 12VDC +] (*Figs. 3c, 3d, pg. 7*).
 7. Connect the terminals marked [+ DATA -] of HubWayAv, HubWayAv2, HubWayDv or HubWayDvi Video Balun/Combiners to data input terminals of cameras for PTZ control (*Figs. 3a-3e, pg. 7*). Polarity must be observed. When using fixed cameras disregard this step.
 8. Connect the BNC connector of HubWayAv, HubWayAv2, HubWayDv or HubWayDvi Video Balun/Combiners to the BNC video outputs of cameras (*Figs. 3a-3e, pg. 7*).
 9. Set illuminated master power disconnect circuit breaker to the RESET (ON) position (*Fig. 4a, pg. 8*).
 10. The power LEDs (Green) of the HubSat4WPV will illuminate when AC power is present (*Fig. 2e, pg. 6*).

Note: If any of the power LEDs are not illuminated the cause may be due to the following:

 - a. AC mains fail.
 - b. Illuminated master power disconnect circuit breaker is tripped.
 - c. An individual power output voltage switch is set to the OFF position (*Fig. 2d, pg. 6*).
 - d. A PTC is tripped due to a short circuit or overload condition for one or more channels/power outputs. To reset the PTC:
 1. Set the voltage output selector switch for that corresponding channel to the OFF position. Switch must remain in the OFF position for approximately 2 minutes in order for the PTC to reset (*Fig. 2d, pg. 6*).
 2. Eliminate the trouble condition (short circuit or overload).
 3. Set the voltage output selector switch for either 24VAC or 28VAC (*Fig. 2d, pg. 6*).

Alternate 24VAC Fixed Camera Hookup (*Fig. 7a, pg. 9*).

After completing steps 1-5 of Installation Instructions Remote Accessory Module for use with HubWay, HubWayLD or HubWayLDH UTP Transceiver Hubs proceed with the following.

1. Set illuminated master power disconnect circuit breaker to the (OFF) position (*Fig. 4a, pg. 8*).
2. Connect one end of the coaxial cable to the BNC connector marked [Video1] on HubSat4WPV (*Fig. 2a, pg. 6*).
Connect the opposite end of the coaxial cable to the BNC video output of camera 1 (*Fig. 6a, pg. 9*).
3. Set illuminated master power disconnect circuit breaker to the RESET (ON) position (*Fig. 4a, pg. 8*). Measure the output voltage at terminal pair marked [AUX1] on HubSat4WPV to ensure proper operation and avoid possible damage (*Fig. 2b, pg. 6*).
4. Connect the power output terminal pair marked [AUX1] on HubSat4WPV to the power inputs of camera 1 (*Fig. 2c, pg. 6*). Repeat steps 1-3 for each additional camera [AUX2-4].

Fig. 1

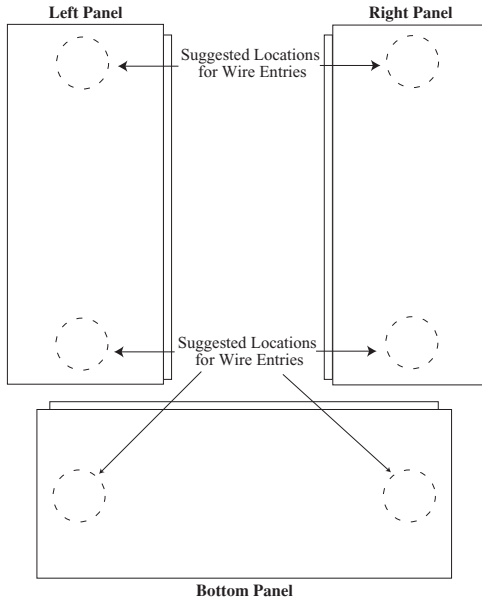
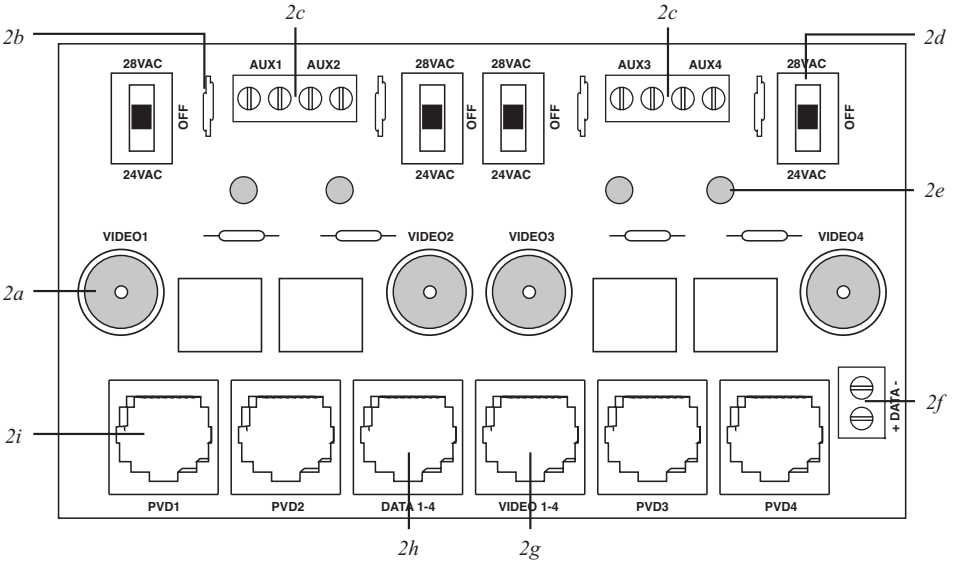

Fig. 2 - HubSat Circuit Board



2a - BNC Connector:

Video in from remote camera video out to DVR.

2b - Output PTCs: Protects each output.

2c - Power Terminals:

24VAC/28VAC power outputs.

2d - Output Voltage Switches:

Selects 24VAC/28VAC/OFF for each output.

2e - LED(s) 1-4:

Power output indicators.

2f - Data:

RS422/RS485 input from head end equipment (DVR) for PTZ control.

2g - Channels 1-4:

Single CAT-5 or higher structured cable out to HubWay, HubWayLD or HubWayLDH enables transmission of up to four (4) video signals. Pin out configuration (pg. 7).

2h - Data:

CAT-5 or higher structured cable to data port on HubWay, HubWayLD or HubWayLDH or head end equipment (DVR).

2i - Channels 1-4:

CAT-5 or higher structured cable to cameras. Pin out configuration (pg. 7).

HubWayAv, HubWayAv2, HubWayDv, and HubWayDvi Video Balun/Combiners:

Altronix Model Number	Input Voltage from HubWay Unit	Output Voltage to Camera	Camera Type	Power LED
HubWayAv	*24VAC/28VAC	*24VAC/28VAC	*24VAC/28VAC	Green
HubWayAv2	*24VAC/28VAC	*24VAC/28VAC	*24VAC/28VAC	N/A
HubWayDv	*24VAC/28VAC	12VDC	12VDC cameras	Red
HubWayDvi	*24VAC/28VAC	12VDC electronically isolated	12VDC cameras without isolation	Red

*Based on camera load and structured cable length.

Fig. 3

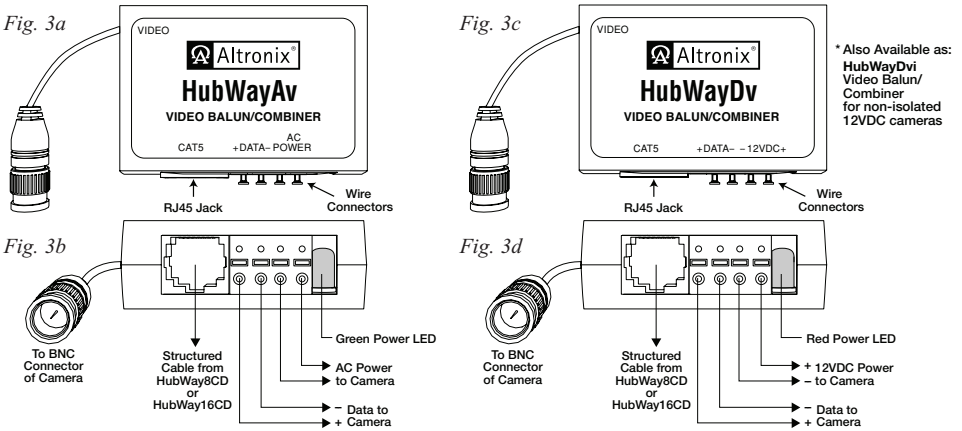
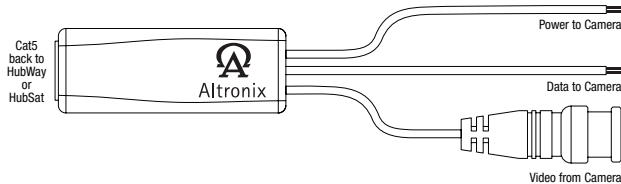

Fig. 3e HubWayAV2



HubWayAv/HubWayAv2 passes AC voltage from pins 4, 5, 7, 8 to terminals marked [AC Power] (Fig. 4, pg. 8).

HubWayDv/HubWayDvi converts AC voltage to DC voltage from pins 4, 5, 7, 8 to terminals marked [- 12VDC +] (Fig. 4, pg. 8).

CAT-5 Structured Cable Wiring Color Codes and PIN Configurations

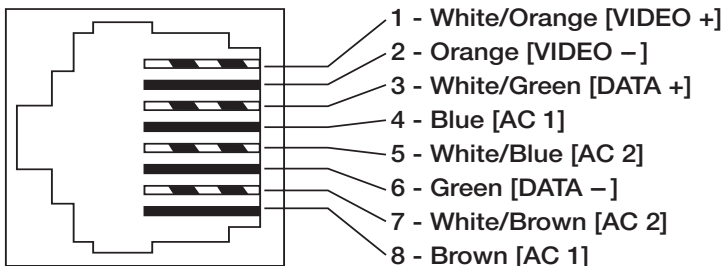

Fig. 4

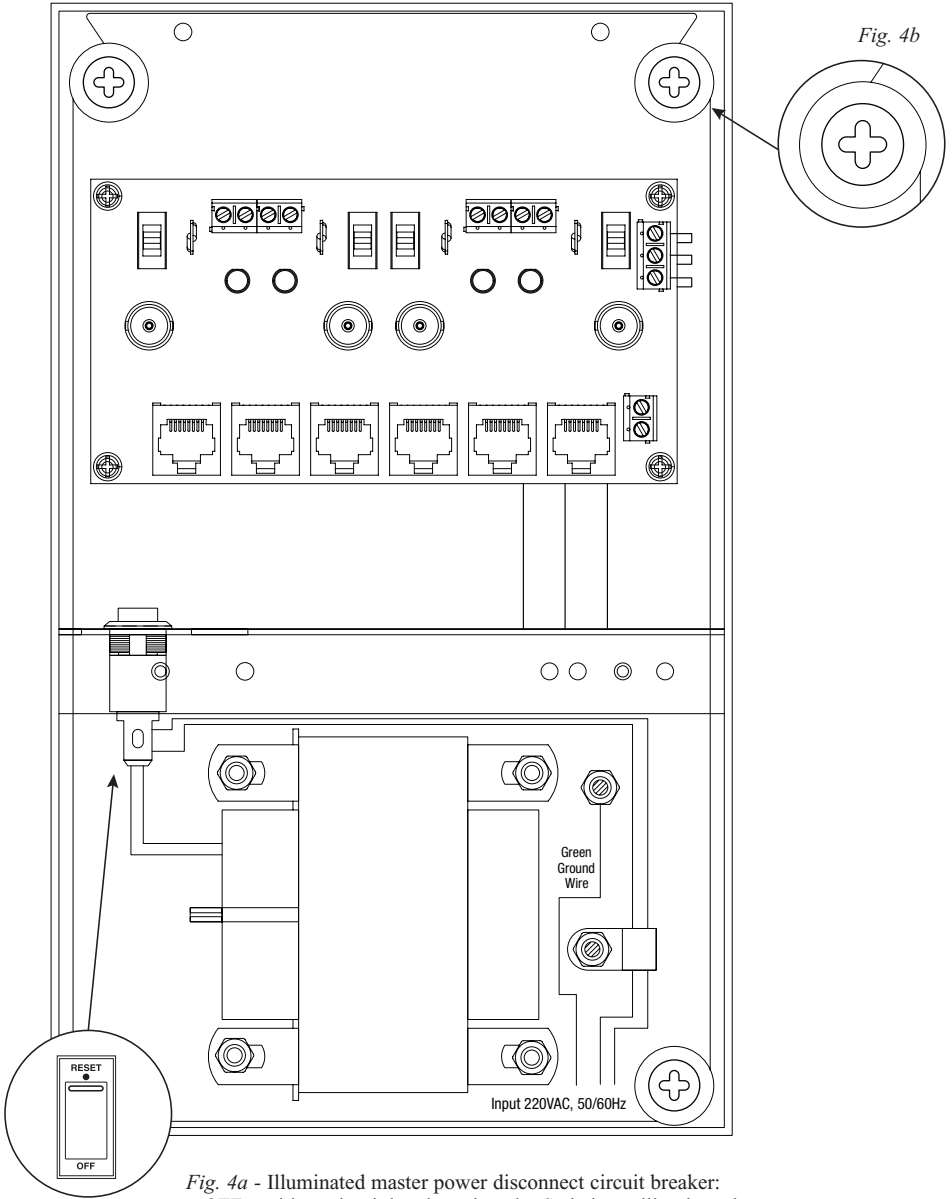
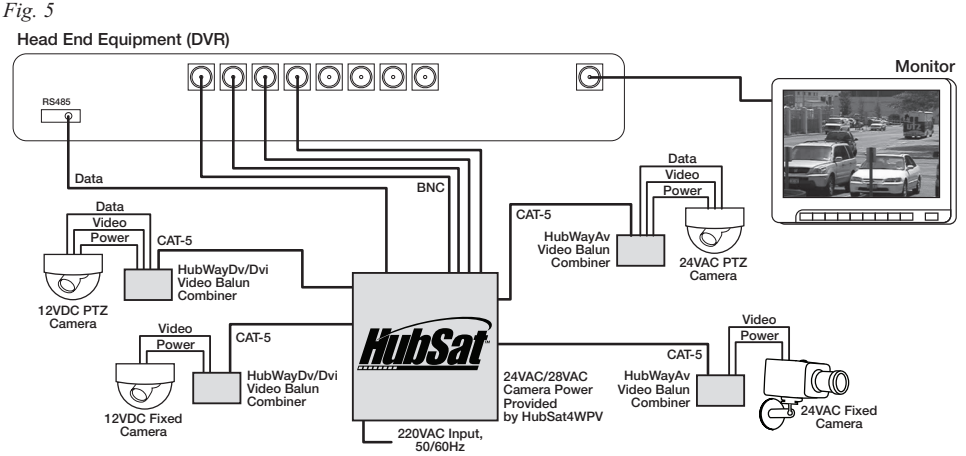

Fig. 4a - Illuminated master power disconnect circuit breaker:
• OFF position: circuit breaker tripped – Switch not illuminated.
• RESET (ON) position – Switch illuminated.

Typical Application Drawing HubSat4WPV Passive UTP Transceiver Hub with Integral Camera Power:



Typical Application Drawing HubSat4WPV Remote Accessory Module with HubWay UTP Transceiver Hubs:

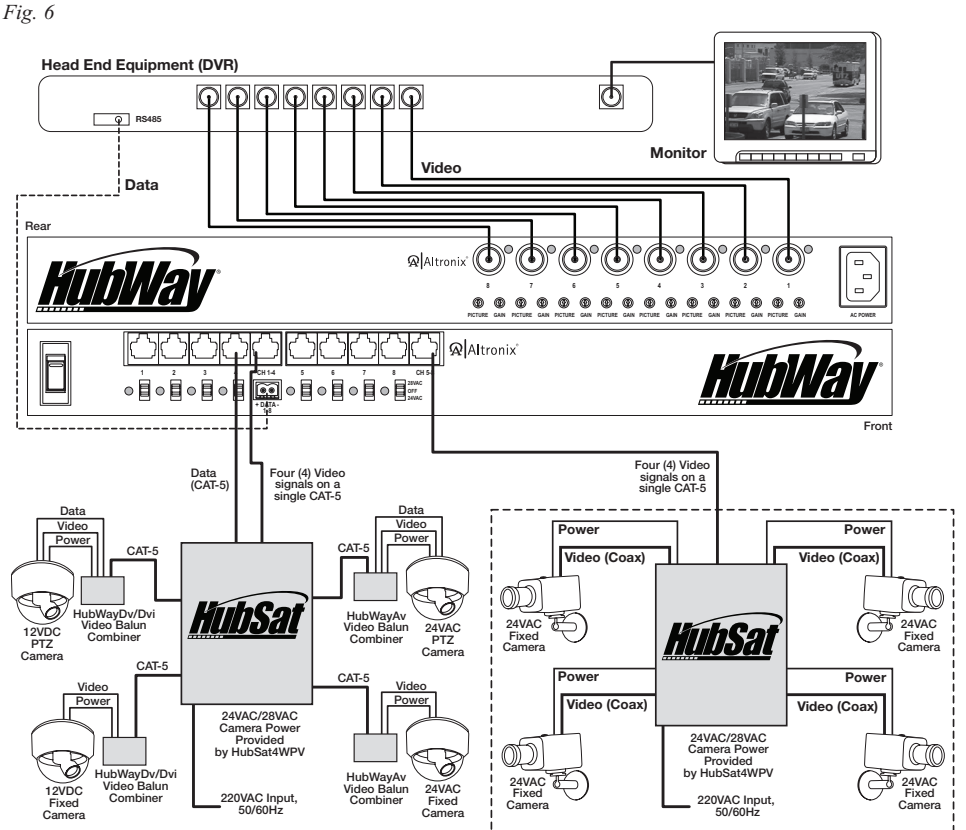
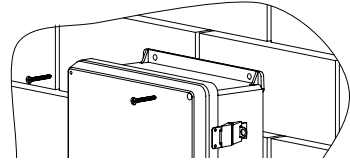

Fig. 6a - Alternate 24VAC fixed camera hookup.

Wall Mount Installation

- 1- Place unit at desired location and secure with mounting screws (not included) (Fig. 7, pg. 10).

Fig. 7



Pole Mounting Using Optional Pole Mount Kit PMK1 (not included):

This installation should be made by qualified service personnel. This product contains no serviceable parts. PMK1 is intended for use with Altronix outdoor rated power supplies or accessories housed in WP1, WP2, WP3 and WP4 enclosures. Brackets are designed for use with the Wormgear Quick Release Straps (two included).

1. Thread one (1) wormgear quick release strap through the slots on the back of a mounting bracket (Fig. 8, pg. 10).
2. Once the desired height of the top Pole Mount bracket is achieved, tighten the straps down by sliding open end of the strap through the locking mechanism on the strap, then tighten the screw with flat head screwdriver or 5/16" hex socket driver (Fig. 9, pg. 10 and Fig. 11, pg. 10).

Fig. 8

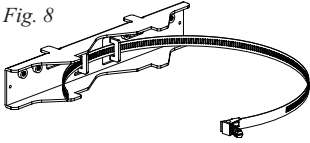

Fig. 9

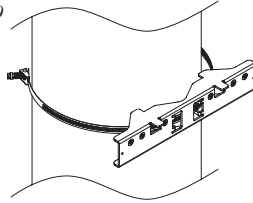
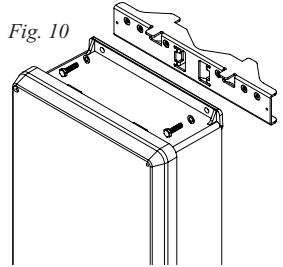

Fig. 10



3. Attach the bottom bracket to the enclosure by inserting bolts through the flange of the enclosure and into the bracket, tightening bolts with a 7/16" hex socket (Fig. 10, pg. 10).
4. Thread the second wormgear quick release strap through the slots on the back of the bottom mounting bracket (Fig. 8, pg. 10).
5. Mount enclosure onto the top bracket by inserting bolts through flange of the enclosure and into the bracket, tightening bolts with a 7/16" hex socket (Fig. 10, pg. 10).
6. Tighten the straps of the bottom bracket down by sliding the open end of the strap through the locking mechanism on the strap, then tighten screw with flat head screwdriver or 5/16" hex socket driver (Fig. 8, pg. 10).
7. Clip excess straps.

Fig. 11

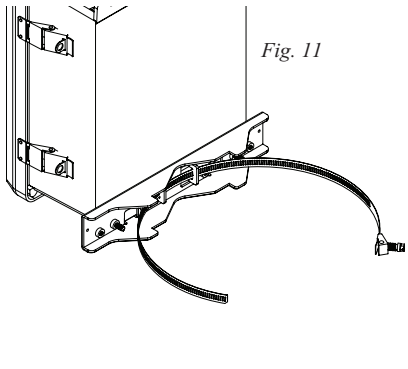

Fig. 12
2" to 8" (50.8mm to 203.2mm)
diameter round pole

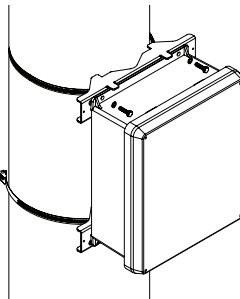
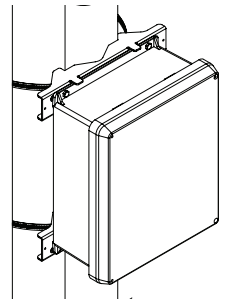

Fig. 12a
5" (127mm) square pole



Notes:



The lightning flash with arrowhead symbol within an equilateral triangle is intended to alert the user to the presence of an insulated **DANGEROUS VOLTAGE** within the product's enclosure that may be of sufficient magnitude to constitute an electric shock.



The exclamation point within an equilateral triangle is intended to alert the user to the presence of important operating and maintenance (servicing) instructions in the literature accompanying the appliance.



CAUTION
RISK OF ELECTRIC SHOCK
DO NOT OPEN



CAUTION: To reduce the risk of electric shock do not open enclosure. There are no user serviceable parts inside. Refer servicing to qualified service personnel.

Enclosure Dimensions (H x W x D approximate):

12" x 8" x 6" (304.8mm x 203.2mm x 152.4mm)

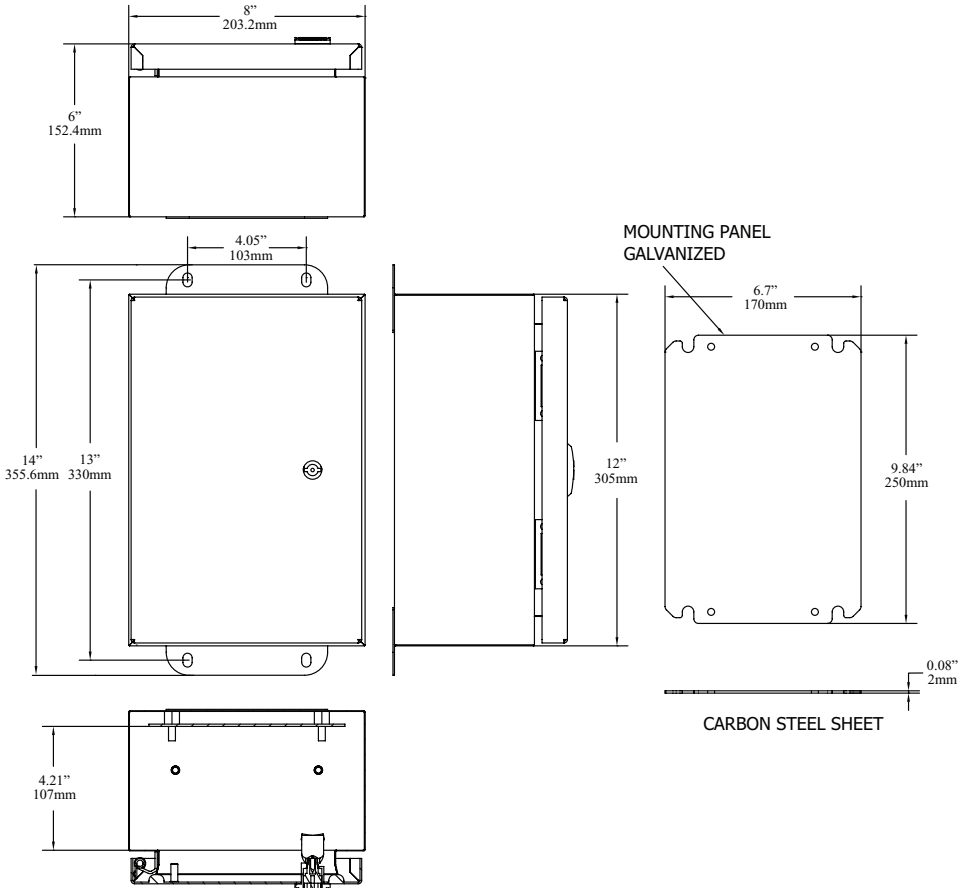

Altronix is not responsible for any typographical errors.

140 58th Street, Brooklyn, New York 11220 USA | phone: 718-567-8181 | fax: 718-567-9056
 website: www.altronix.com | e-mail: info@altronix.com | Lifetime Warranty | Made in U.S.A.
 IIHubSat4WPV H30R

